

TOP
scale 1:3

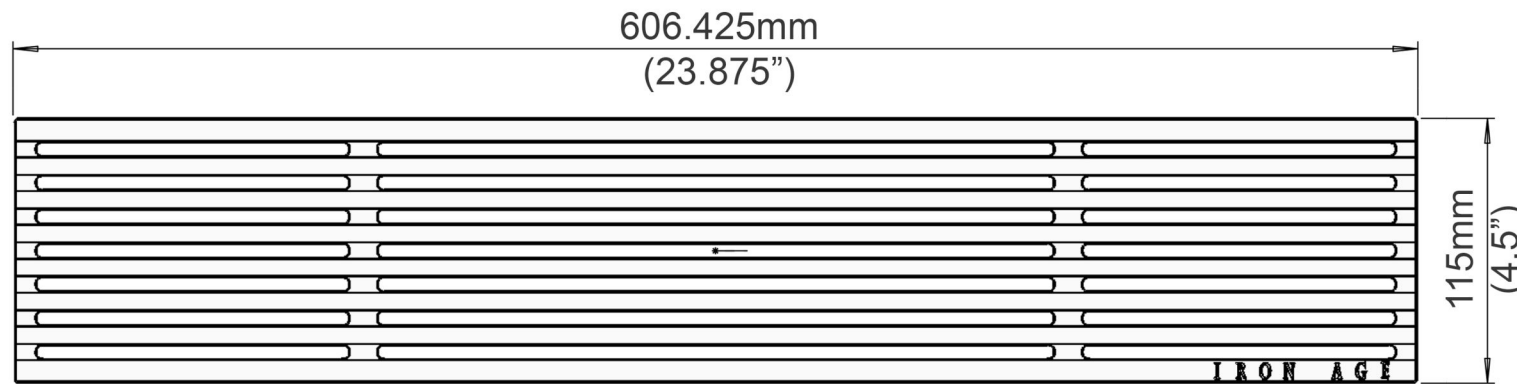

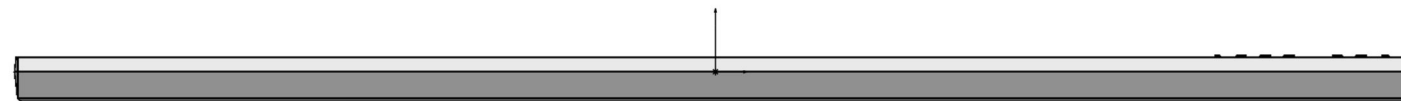

EDGE
scale 1:3

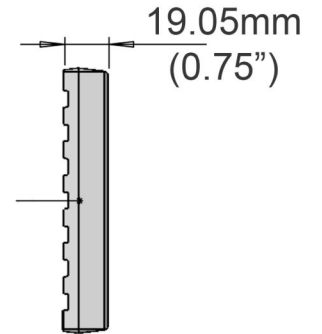

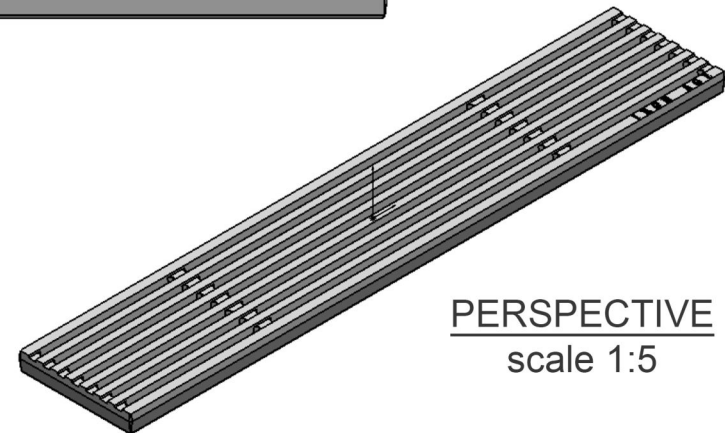
SIDE
scale 1:3



PERSPECTIVE
scale 1:5

	Pattern : Que	Material : Cast Iron	Que 606 x 115 mm Channel Grate	
	Finish : Natural	Thickness : 19.05	4 1/2" x 24" Heelproof Que grate	
1. Due to casting inconsistencies all dimensions are nominal 2. No openings greater than 6.35 mm 3. Please discuss about channel drain options	Dimensions : 606,425 x 115	Units : mm	Drawing no : QUE-CG-606-115 Product no : CI111-606-115CG	
	Load Class : N/A	Flow rate : N/A	 Unit 5 Cotswold Business Park Millfield Lane Beds LU1 4AJ www.lateraldesignstudio.co.uk	
Copyright 2011-2016 Lateral Design Studio Limited. This drawing and subject matter disclosed therein, embody proprietary information which is the confidential property of Lateral Design Studio Ltd, none of which shall be copied, reproduced, disclosed to others, published or used, in whole or in part, without the express advanced written permission of a duly authorised agent of the company. This drawing is subject to recall by Lateral Design Studio Ltd.		 info@lateraldesignstudio.co.uk		0208 450 2244